

FE..

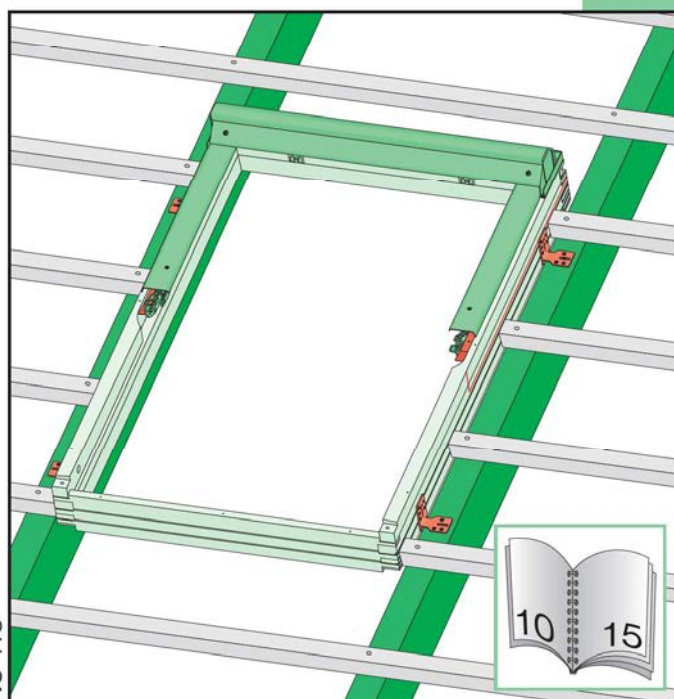
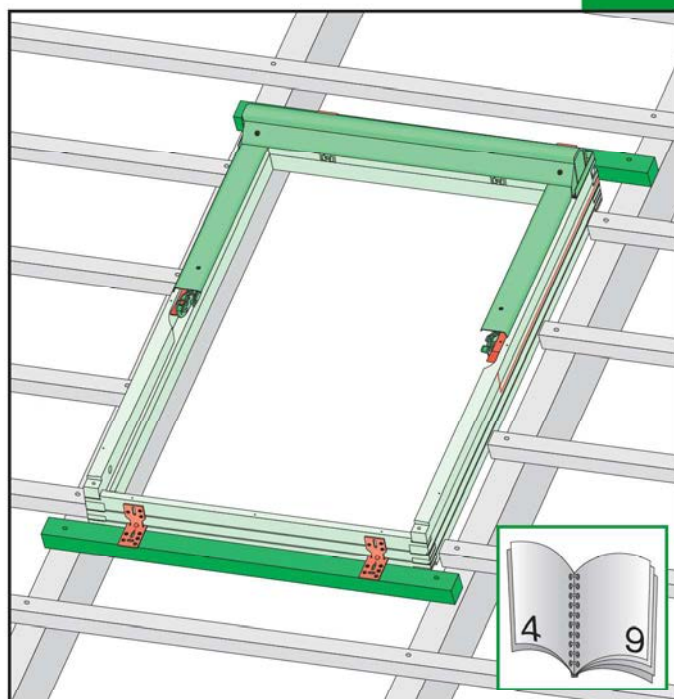

NC 118

CZ Výrobce a Prodejce nenesí žádnou odpovědnost za nedodržení příslušných předpisů zákona, stavebních předpisů a bezpečnostních požadavků plus uživatele výrobku, architektu, montážní nebo majitele objektu.

D Hersteller und Verkäufer übernehmen keine Haftung für Nichtbeachtung entsprechender Rechts- und Bauvorschriften sowie Sicherheitsanforderungen seitens Produktbenutzers, Architekten, Monteurs oder Gebäudebesitzers.

E El fabricante y el vendedor no tienen ninguna responsabilidad por el incumplimiento de la ley vigente, normas de construcción y exigencias de seguridad por parte del usuario del producto, arquitecto, instalador o el propietario del edificio.

FR Le fabricant et le revendeur ne prend aucune responsabilité de ne pas respecter les lois applicables, les règlements sur les bâtiments et les exigences de sécurité par l'utilisateur du produit, l'architecte, l'installateur ou le propriétaire du bâtiment.

GB Manufacturer and Seller shall bear no liability for failure to comply with the applicable laws, building codes and safety requirements by the user of the product, architect, fitter or owner of the building.

H A gyártó és a forgalmazó nem vállal semmilyen felelősséget a vonatkozó törvényi, építészeti és biztonsági előírások, tervezési és biztonsági követelmények, építési, biztonságos használati vagy építésszakemberek által be nem tartásáért.

I Il Produttore e il Rivenditore non potranno essere ritenuti responsabili per il mancato rispetto, da parte dell'utente del prodotto, del progettista, dell'installatore o del proprietario dell'edificio, delle leggi vigenti, nonché dei regolamenti edilizi e di quelli relativi alla sicurezza.

NL De fabrikant en verkoper zijn niet aansprakelijk voor gevolgen bij het niet opvolgen van toepasselijke wetten, bouwbesluiten en veiligheidsvoorschriften door de gebruiker van het product, de architect, de installateur of de eigenaar van het gebouw.

PL Producent i Sprzedawca nie ponosi żadnej odpowiedzialności za nieprzeobrażenie stosownych przepisów prawa, przepisów budowlanych i wymogów bezpieczeństwa przez użytkownika produktu, architekta, montażystę lub właściciela budynku.

RU Ни производитель, ни дистрибутор ни в коем случае несут ответственности за несоблюдение действующих законов, строительных норм и правил, требований безопасности и требований безопасности при эксплуатации здания.

RUS Производитель и продавец несут ответственность за несоблюдение действующих строительных правил и норм безопасности ответственность с производителя и продавца снимается.

SK Výrobca a predajca nenesú žiadnu zodpovednosť za nedodržanie príslušných ustanovení zákona, stavebných predpisov a bezpečnostných požiadaviek užívateľom výrobku, architektom, montážom alebo majiteľom objektu.

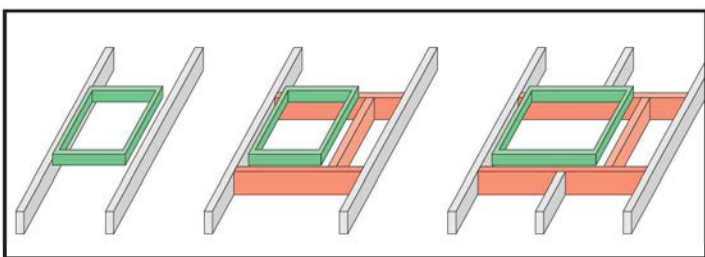
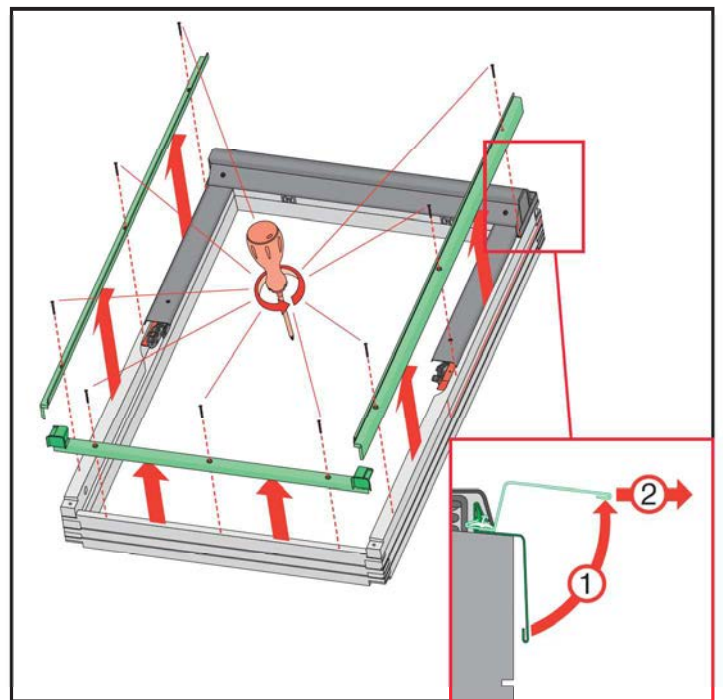
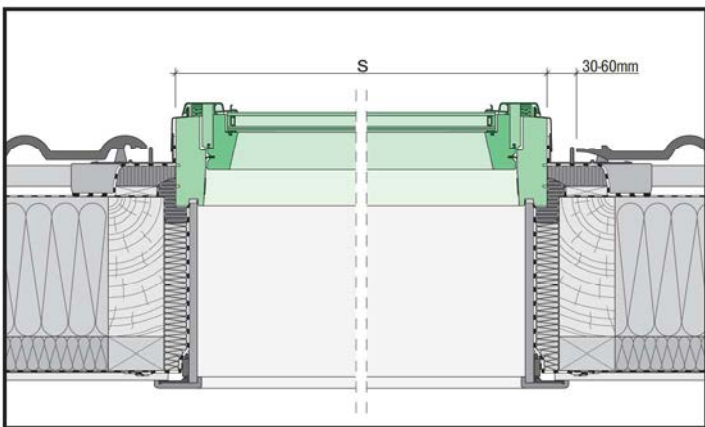
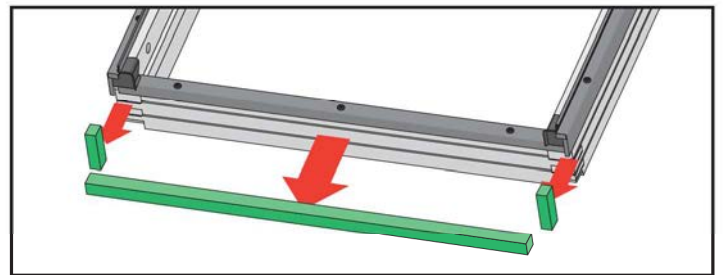
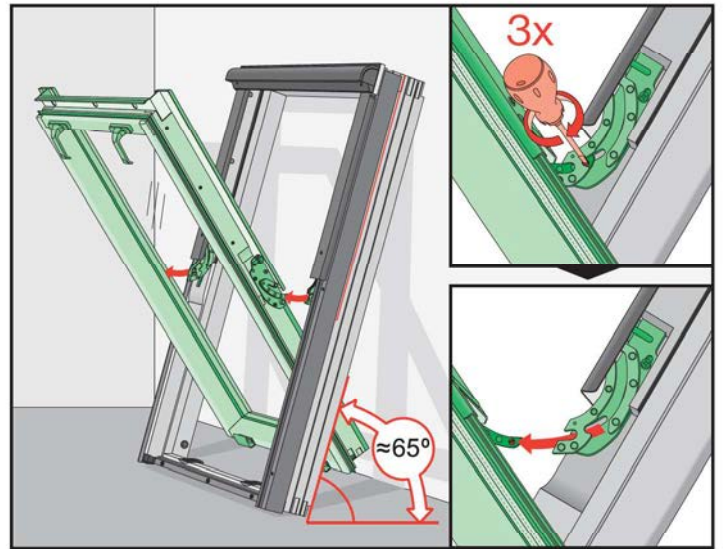
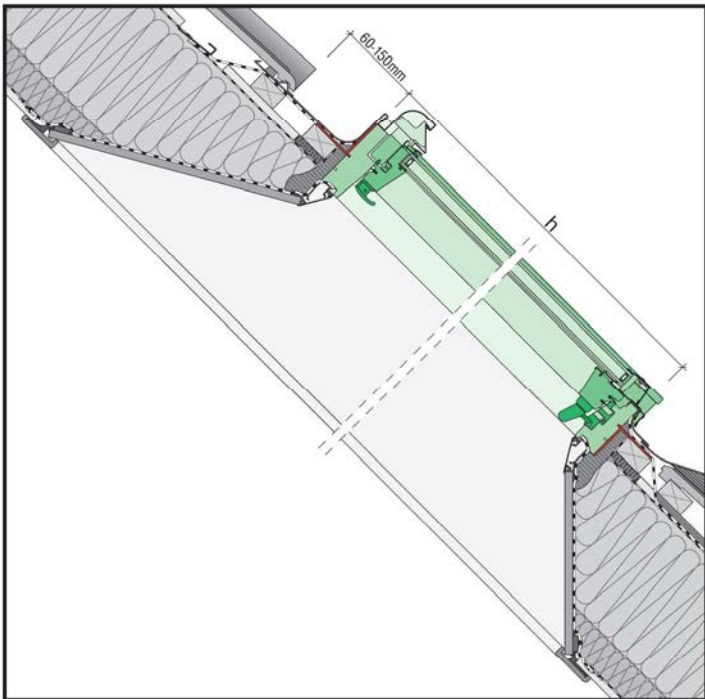
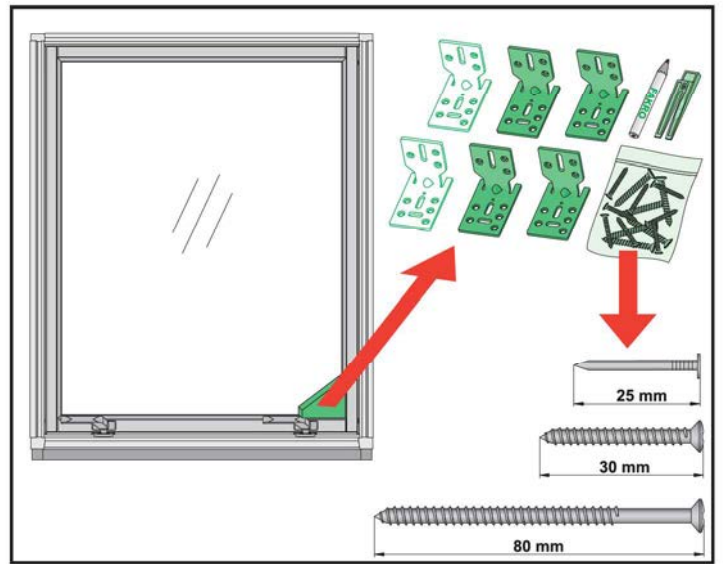
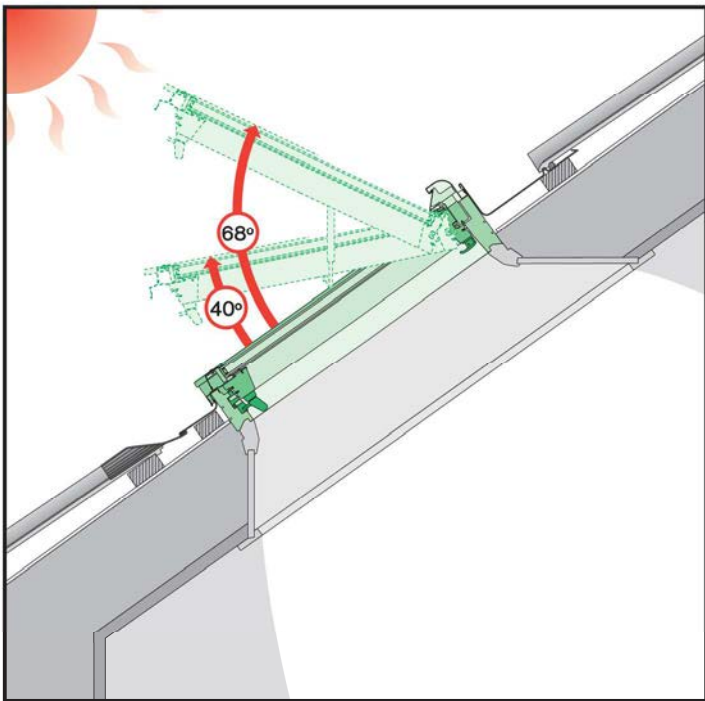

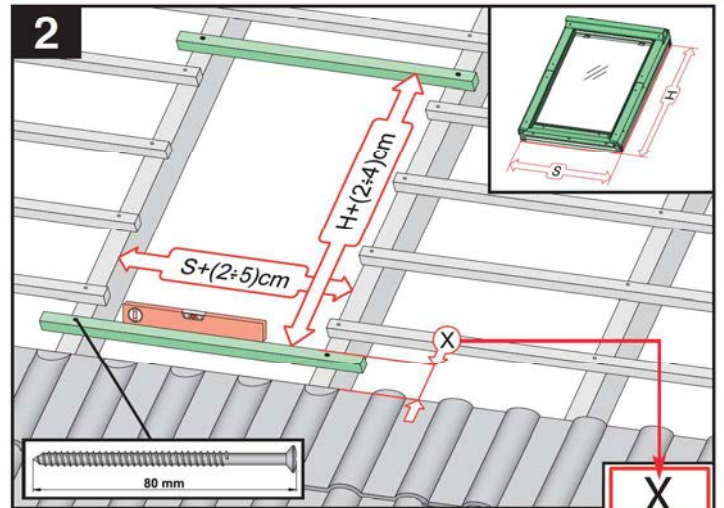
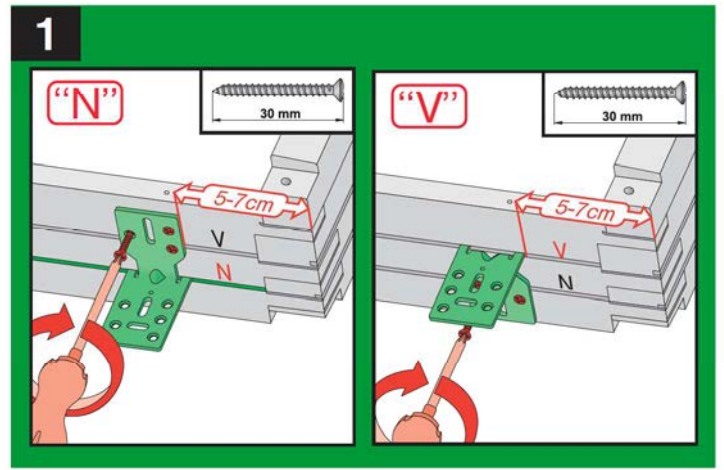
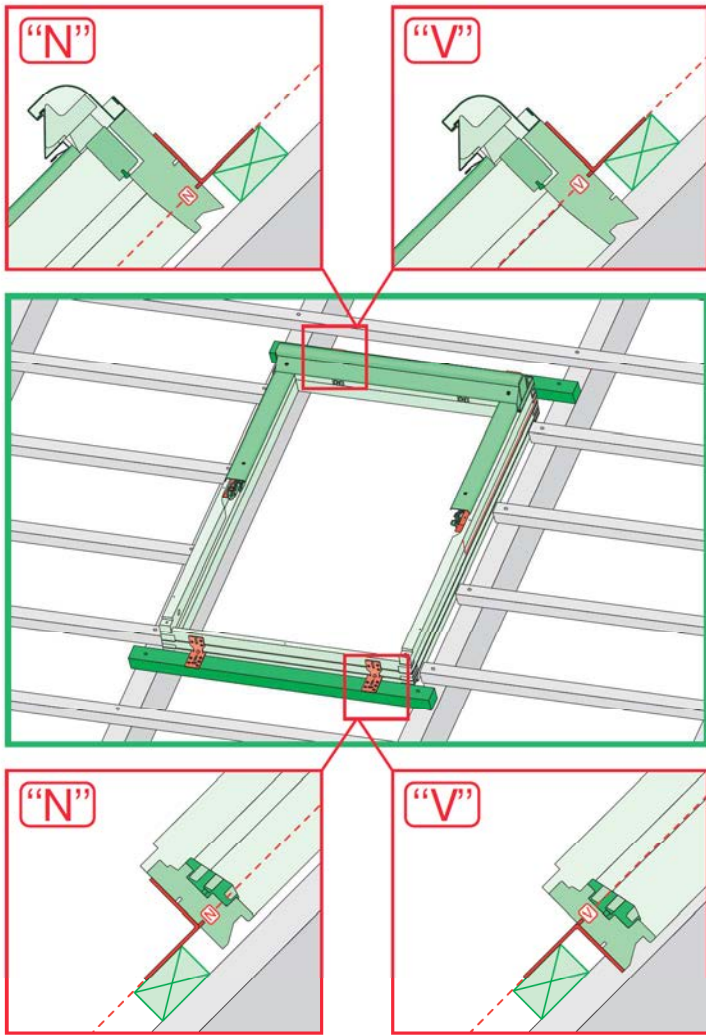

| | | | | | |
|--|--|-----------------------------|----|------------|------------------|
| | | max 90mm | EH | EHN EHV | 7-10cm 7-10cm |
| | | max 45mm | EZ | EZN EZV | 6-8cm 6-8cm |
| | | 12-16mm 380-420mm | EG | EGV | 4cm |
| | | max 18mm 250-280mm | EP | EPV | 6cm |
| | | max 5mm (V) max 15mm (N) | EL | ELN ELV | 0-2cm 0-2cm |
| | | | EE | EEN EEV | 0-2cm 0-2cm |

| | | | | | |
|--|--|-----------------------------|------------|--|--------------------|
| | | max 90mm | EHN EHV | | 15°-90° 15°-90° |
| | | max 45mm | EZN EZV | | 15°-90° 15°-90° |
| | | max 15mm (N) max 5mm (V) | ELN ELV | | 15°-90° 15°-90° |
| | | max 5mm | ESN ESV | | 15°-90° 15°-90° |

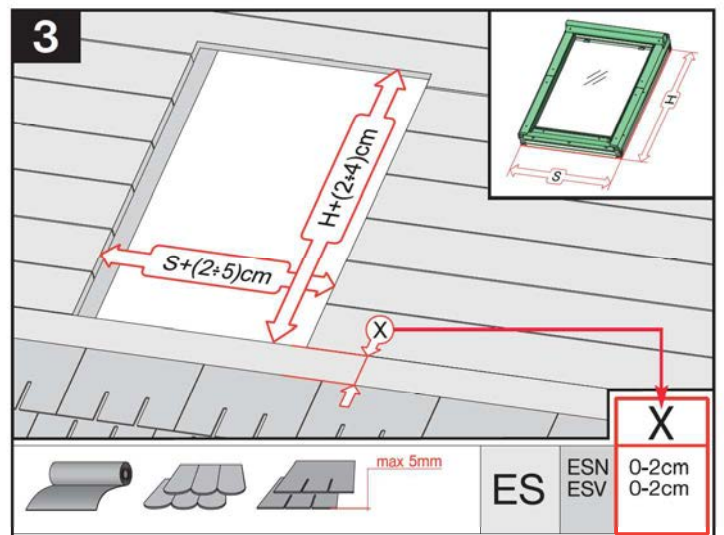

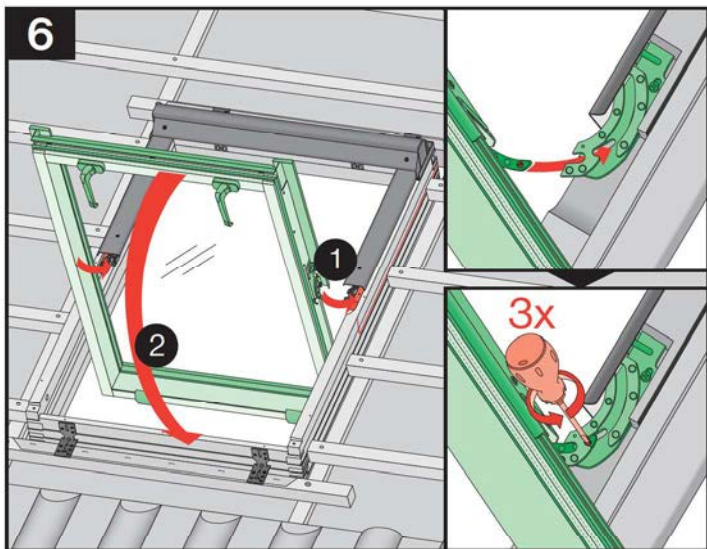
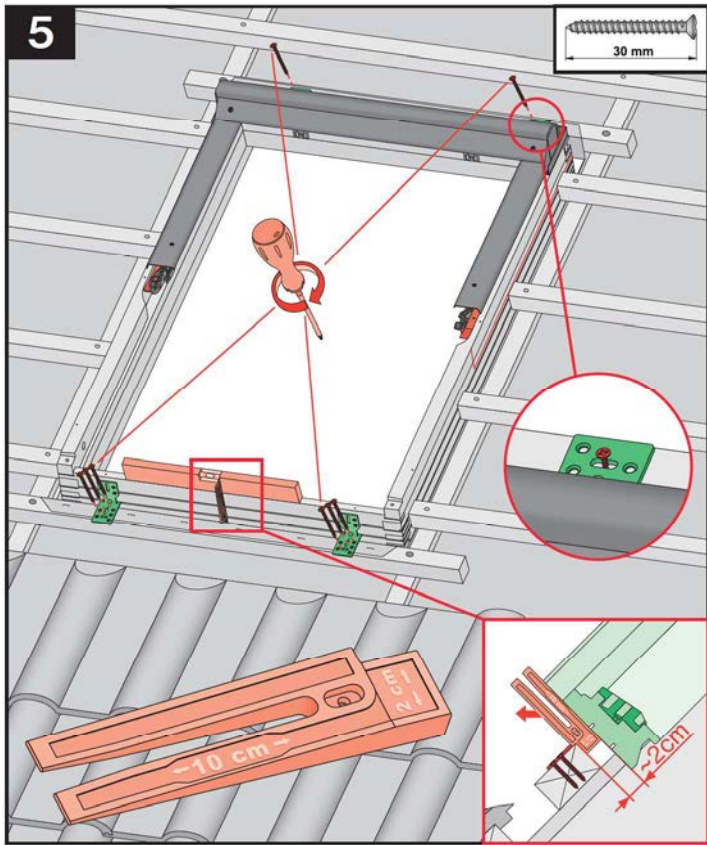
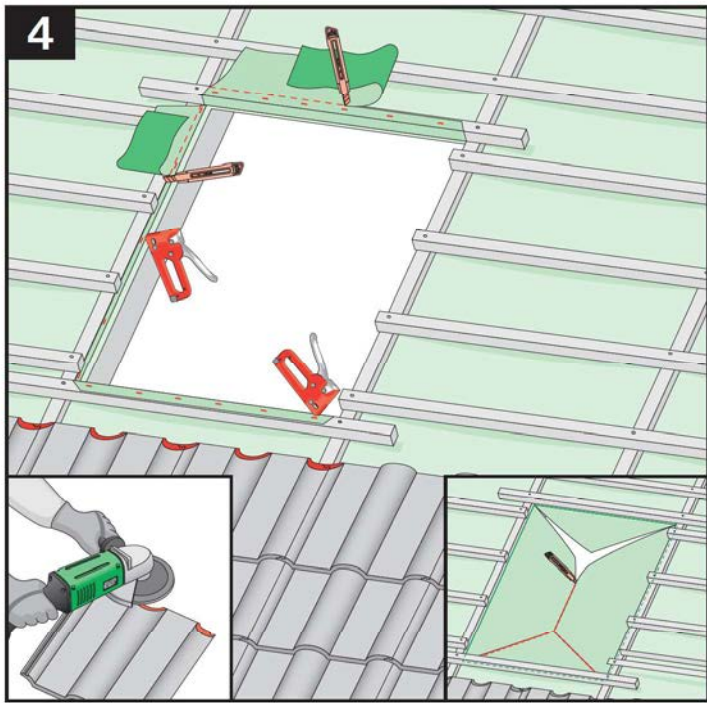



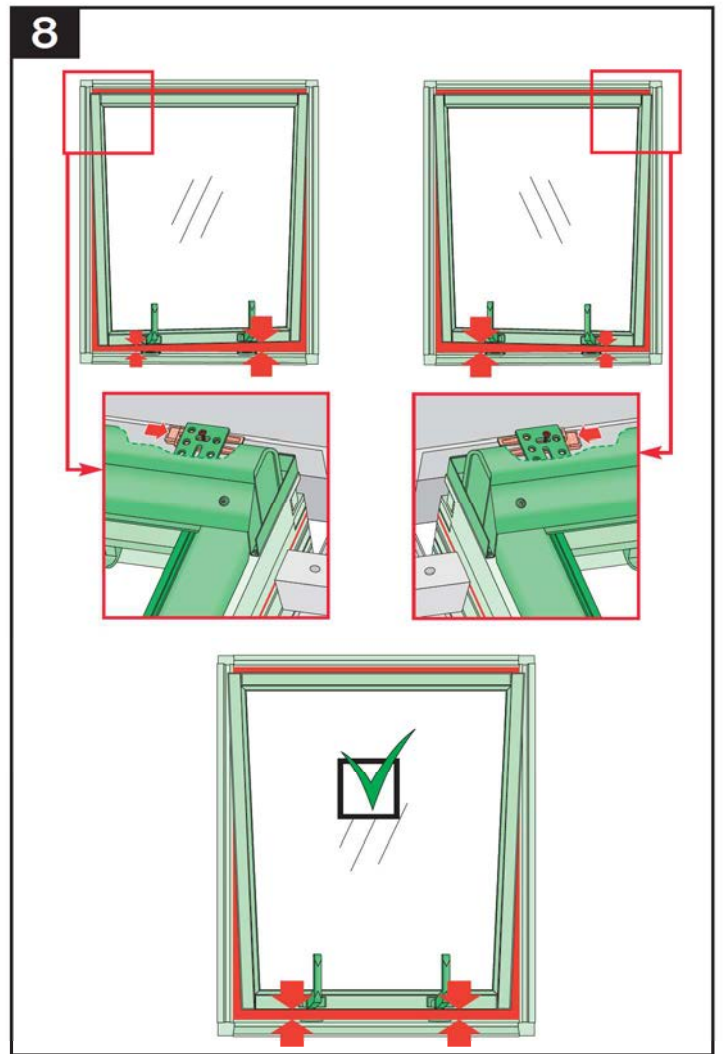
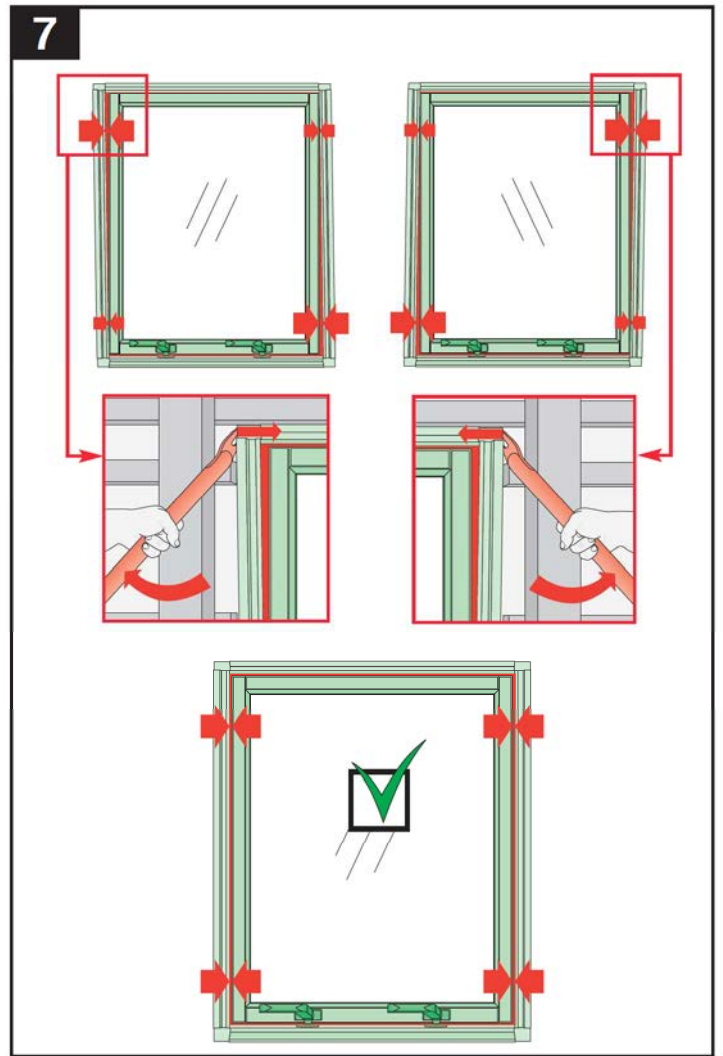



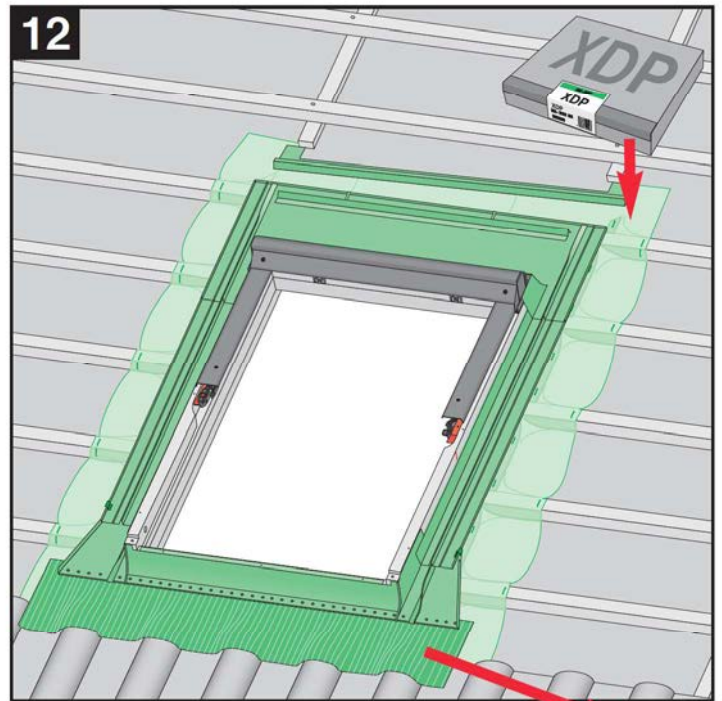
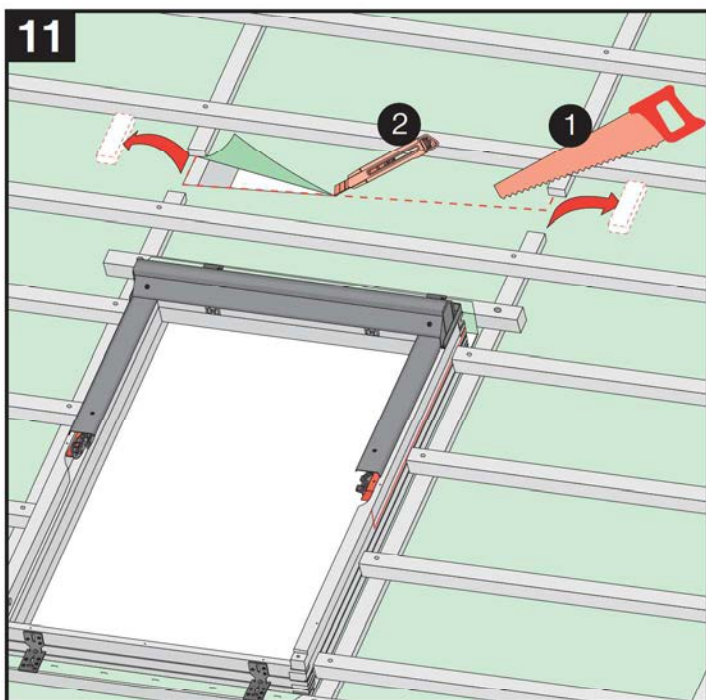
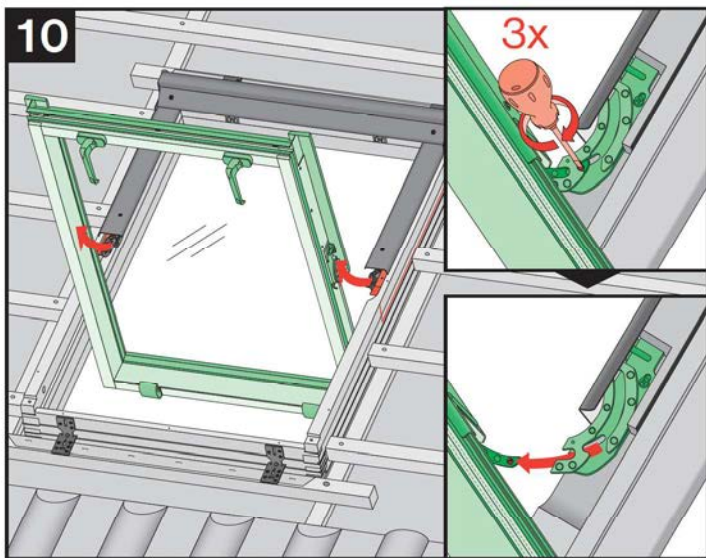
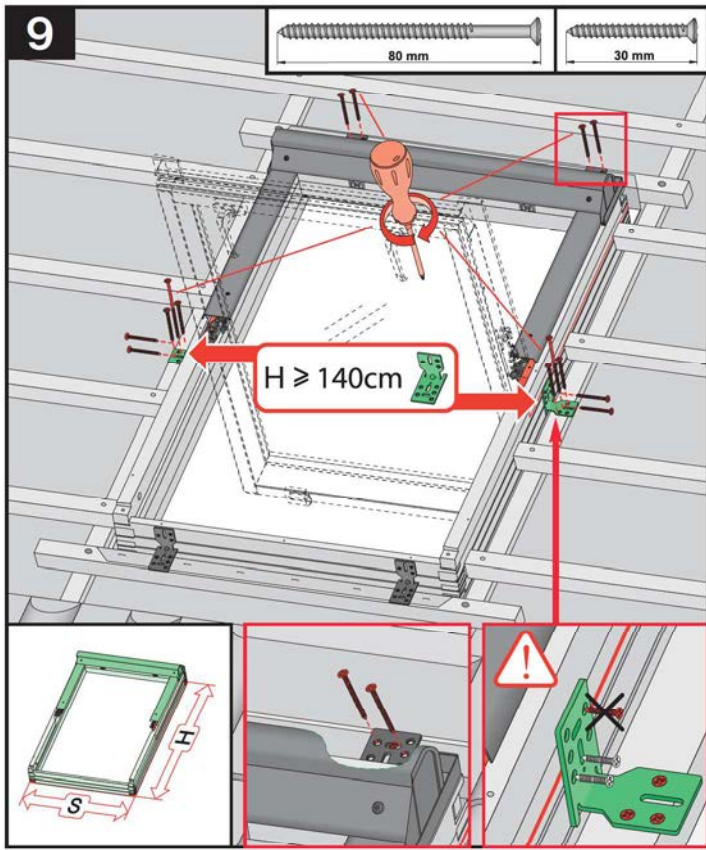







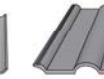

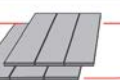
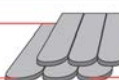

6

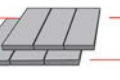

7



| | | | | |
|---|---|---|-----------------------------|------------|
|  |  |  | max 90mm | EHN EHV |
|  |  |  | max 45mm | EZN EZV |
|  |  |  | max 5mm | ESN ESV |
|  |  |  | 12-16mm | EGV |
|  |  |  | max 18mm | EPV |
|  |  | | max 5mm (V) max 15mm (N) | ELN ELV |
|  |  | | | EEN EEV |

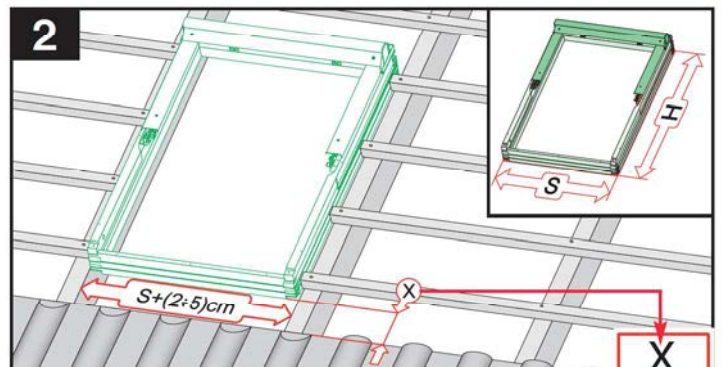
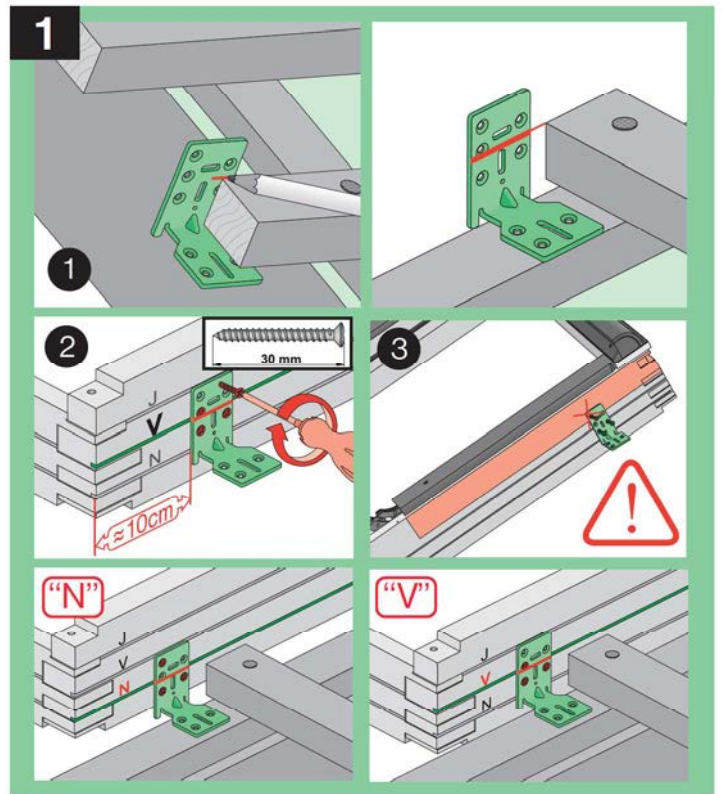
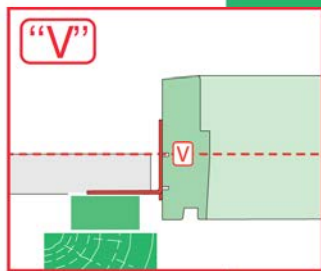
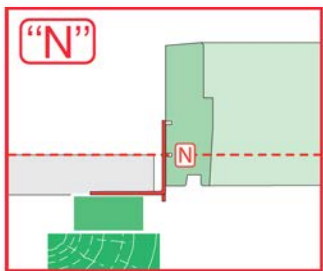
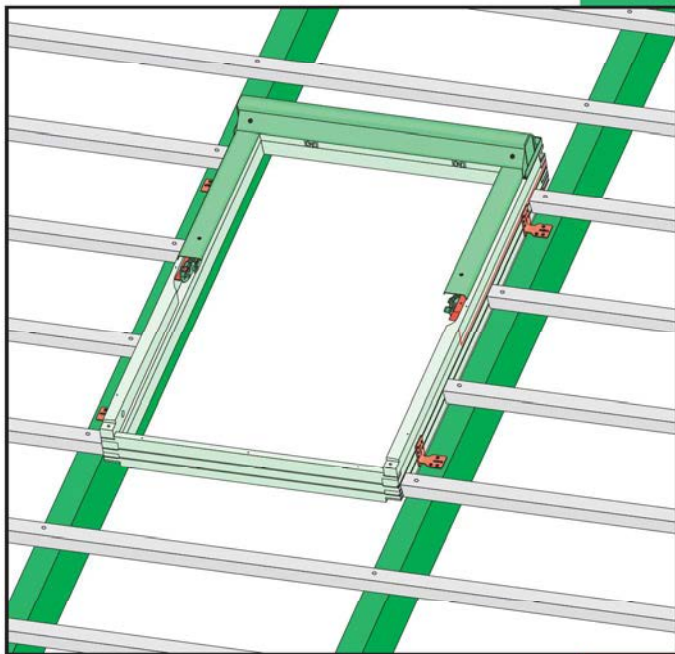

| | | | | | | | | |
|--|--|-----------------------------|-----|---|---------|-----|-----|--------|
| | | max 90mm | EHN | | 15°-90° | EH | EHN | 9-12cm |
| | | max 45mm | EHV | | 15°-90° | | EHV | 9-12cm |
| | | max 45mm | EZN | | 15°-90° | EZ | EZN | 8-10cm |
| | | max 45mm | EZV | | 15°-90° | EZV | EZV | 8-10cm |
| | | max 15mm (N) max 5mm (V) | - | - | - | EG | EGV | 6cm |
| | | max 18mm | - | - | - | EP | EPV | 8cm |
| | | max 5mm (V) max 15mm (N) | ELN | | 15°-90° | EL | ELN | 0-4cm |
| | | max 5mm (V) max 15mm (N) | ELV | | 15°-90° | ELV | ELV | 0-4cm |
| | | max 5mm | - | - | - | EE | EEN | 0-4cm |
| | | max 5mm | - | - | - | EEV | EEV | 0-4cm |

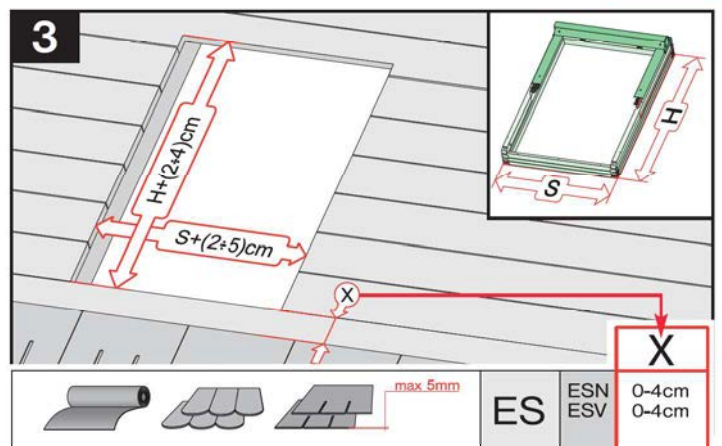

| | | | | | | | | |
|--|--|---------|-----|--|---------|----|-----|-------|
| | | max 5mm | ESN | | 15°-90° | ES | ESN | 0-4cm |
| | | max 5mm | ESV | | 15°-90° | | ESV | 0-4cm |

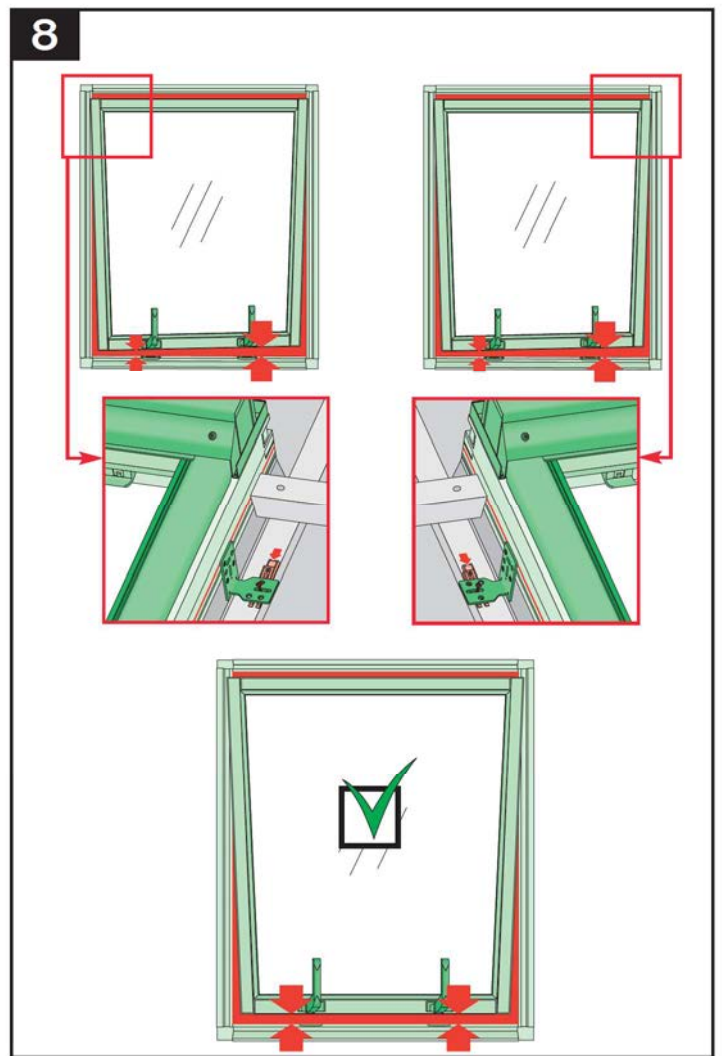
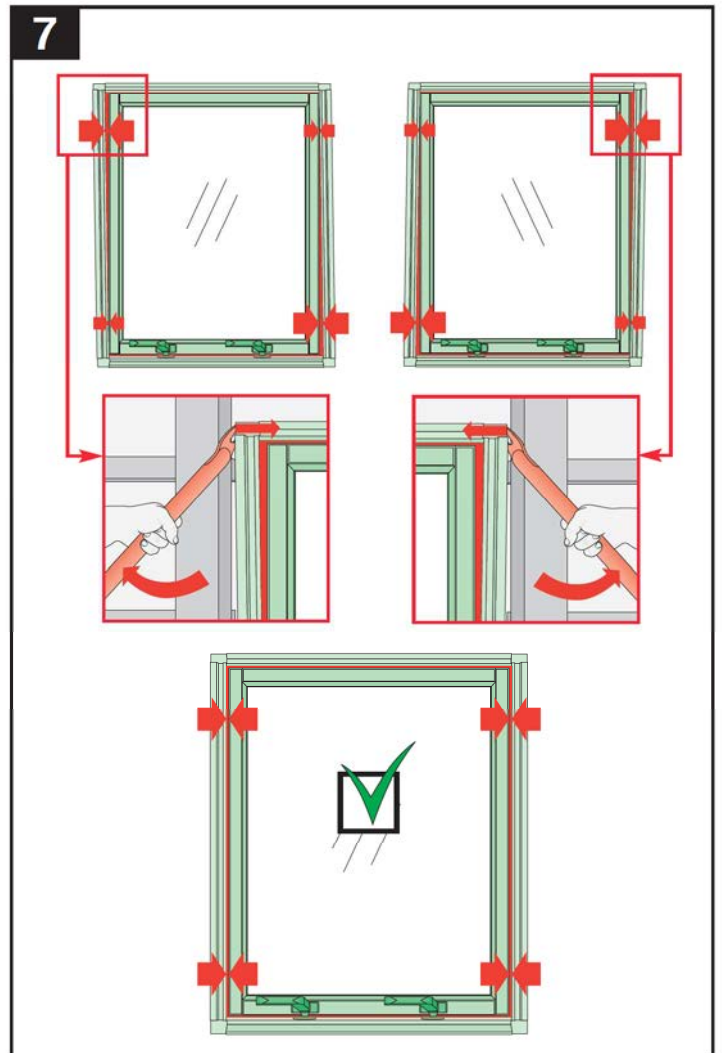
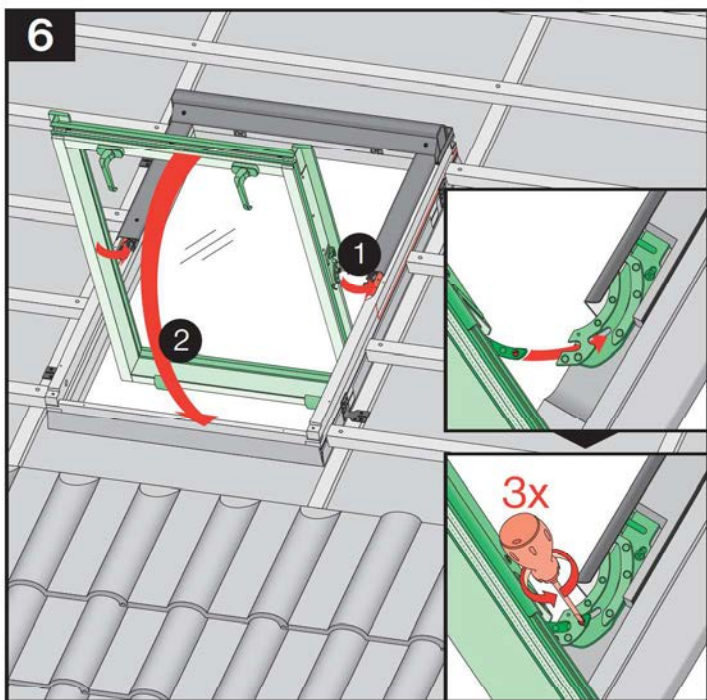
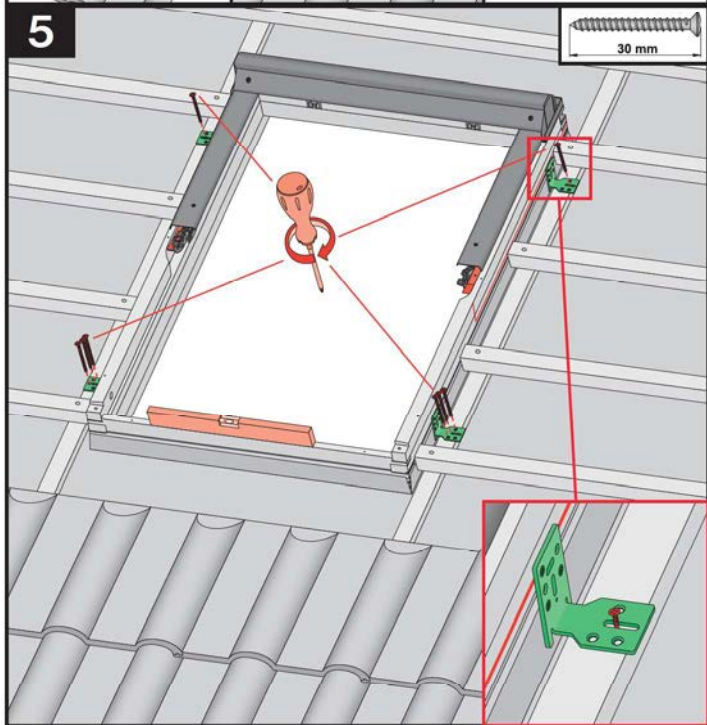
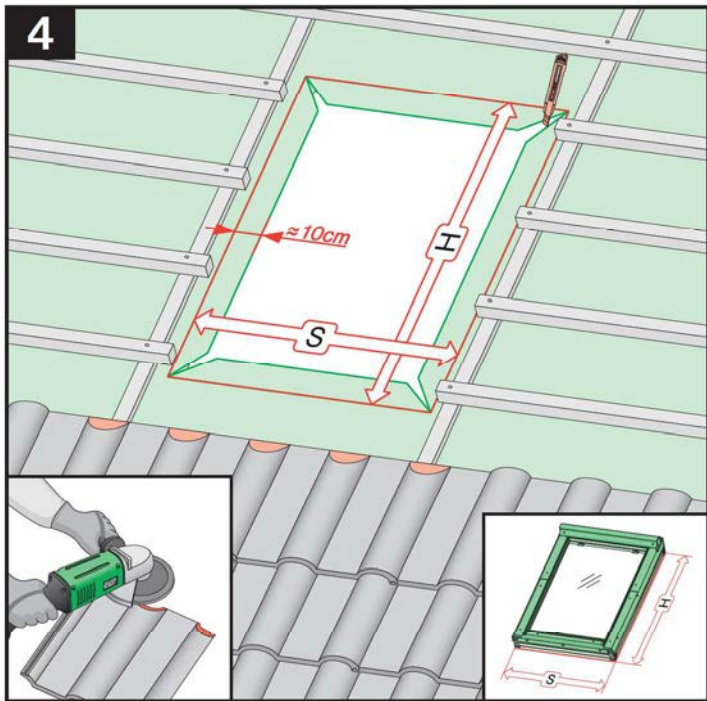

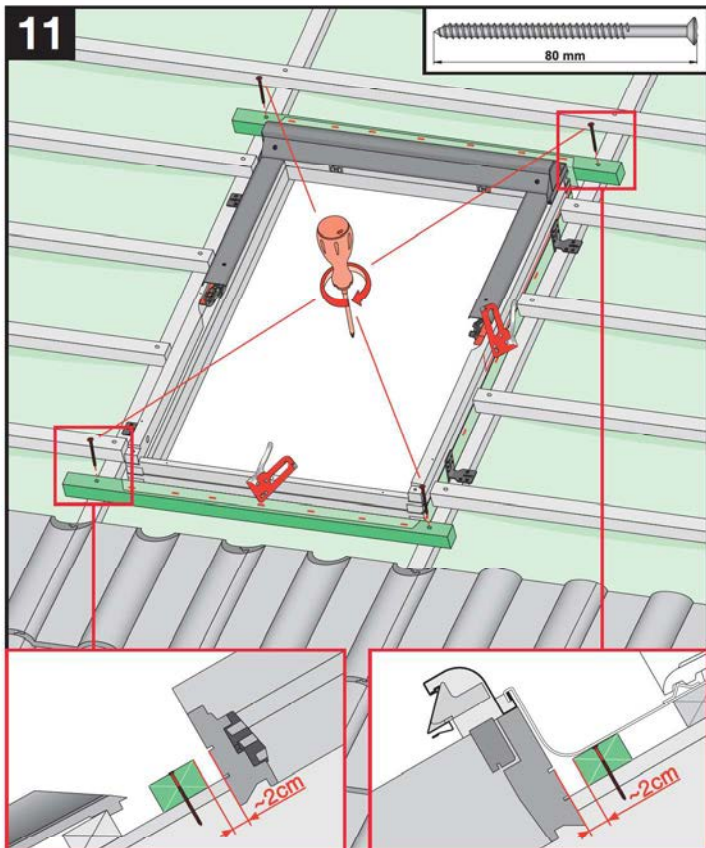
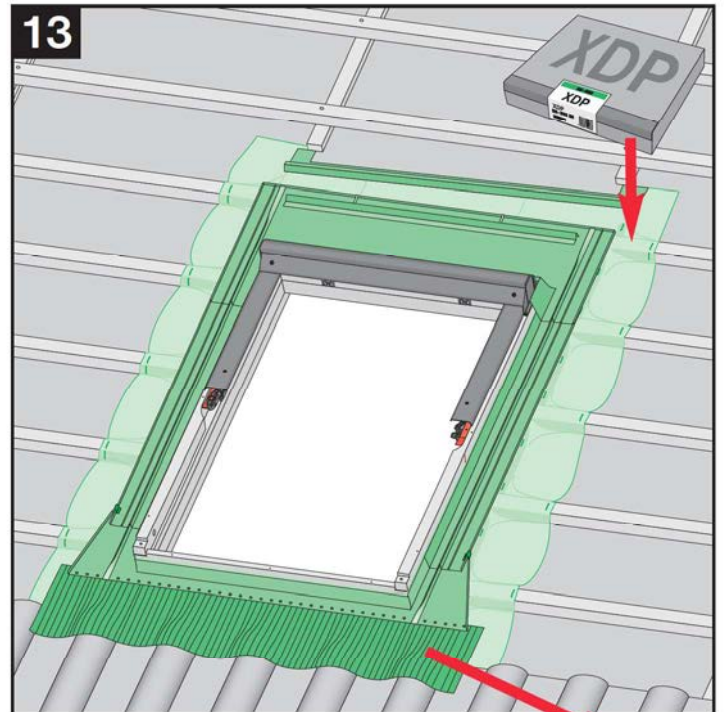
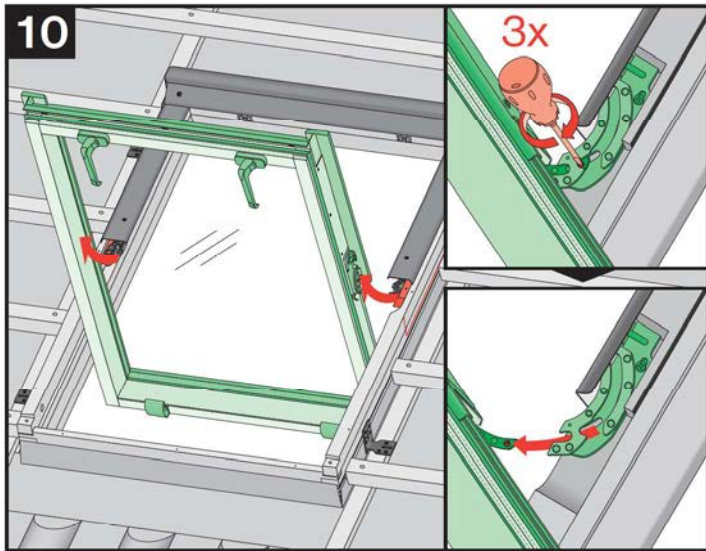
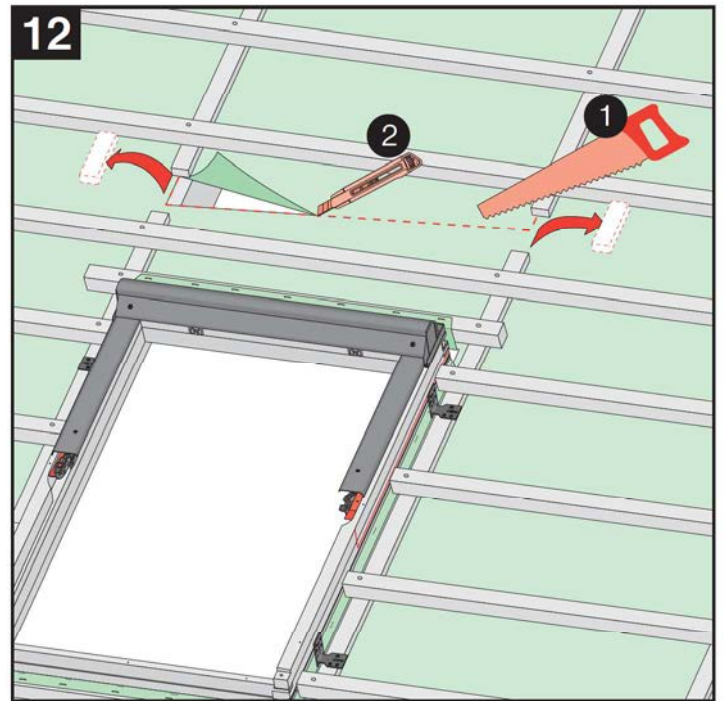
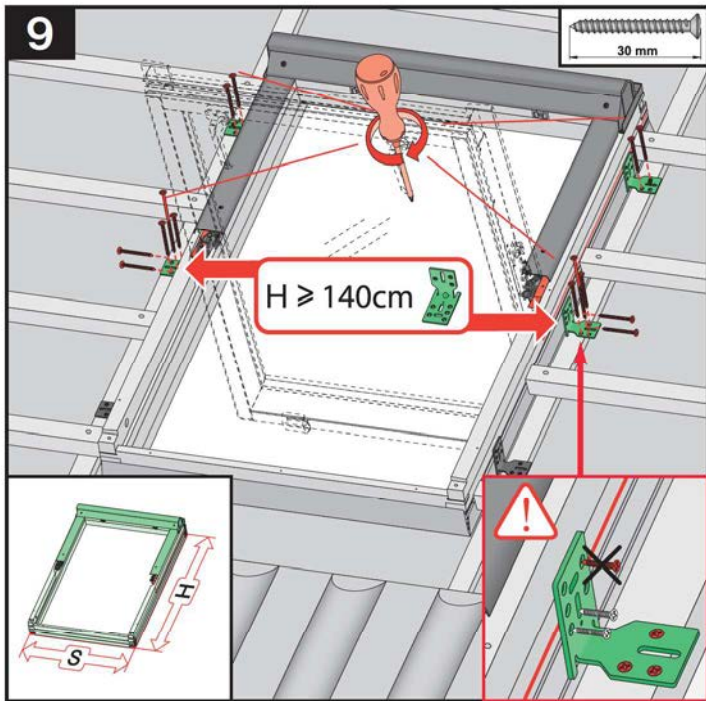

| | | | | |
|--|--|--|-----------------------------|------------|
| | | | max 90mm | EHN EHV |
| | | | max 45mm | EZN EZV |
| | | | max 5mm | ESN ESV |
| | | | 12-16mm | EGV |
| | | | max 10mm | EPV |
| | | | max 5mm (V) max 15mm (N) | ELN ELV |
| | | | | EEN EEV |